

coemar

DIGifactor 12 ch 2 Kw

**instruction
manual**

3st edition, june 1998

Index

- 1. Introduction**
- 2. Technical characteristics**
- 3. Mechanical installation**
- 4. Connection to mains power**
- 5. Load connection**
- 6. Signal connection**
 - 6.1 DMX 512**
 - 6.2 0/+10VDC**
- 7. Powering up**
- 8. DMX addressing or analogue 0/+10v DC**
 - 8.1 0/+10V DC**
 - 8.2 DMX 512**
- 9. Display panel functions**
 - 9.1. Test**
 - 9.1.1. Testing individual channels**
 - 9.2 Electrical and electronic displays**
 - 9.2.1. Voltage**
 - 9.2.2. Frequency**
 - 9.2.3. Temperature**
 - 9.2.4. DIGifactor hours of operation**
 - 9.2.5. DMX 512 parameter displays**
 - 9.2.6. Measuring the signal level for each channel with DMX 512 signal**
 - 9.2.7. Measuring the signal level for each channel with 0/10V DC signal**
 - 9.2.8. Measuring the output voltage on each channel**
 - 9.3 Advanced functions (installer options)**
 - 9.3.1. Lamp pre-heating**
 - 9.3.2. Setting individual channel output voltage limits**
 - 9.3.3. Setting channels to on/off operation (switching)**
 - 9.3.4. Switching channels - pre-heating**
 - 9.3.5. Setting the response curve for the strike signal**
 - 9.3.6. Recording output levels**
 - 9.3.7. Selecting back-up scene**
 - 9.3.8. Protection against overheating**
 - 9.3.9. Resetting the DIGifactor**
 - 9.3.10. Viewing recorded scenes**
 - 9.3.11. Switching off pre-recorded scenes**
- 10. Activating a back-up scene by remote**
- 11. Error messages**
- 12. Maintenance**
- 13. Spare parts**

1. Introduction

Congratulations on having purchased a new **coemar** product. You have ensured yourself of a controller of the highest quality, both in the components and in the technology used.

In any request for information regarding the **DIGifactor 12 ch 2 Kw**, we ask that you specify correctly the model purchased. To this end we request that you complete the purchase details listed below. This information will assist us in providing you with prompt and accurate information.

2. Technical characteristics

DIGifactor 12 ch 2 Kw is a dimmer rack allowing control over the output of 12 channels from 0 to 230V. Each of the 12 channels may be loaded to a maximum of 2.3KW; therefore resulting in a maximum current of 10 Amps per channel.

mechanical:

- Mounting bars to allow fixing to a variety of surfaces
- Hinged front panel to allow easy internal inspection
- Maximum ambient operating temperature: 40 °C
- Weight: 12.2 Kg.

electrical:

- Power supply 230V three phase delta or star
- Voltage over-supply protection
- Load protection via ceramic fuses
- Maximum load per channel: 2.3KW
- Number of channels: 12.
- CE compliance
- Locking load connectors
- Locking supply connectors
- Fuse-blown indicator on all supply outlets

electronics:

- Load voltages controlled by either 0/+10 v DC or DMX 512 signal
- Single channel test facility
- Digital DMX 512 addressing.
- Internal measurement of each of the three phases
- Internal measurement of supply frequency
- Instantaneous internal temperature measurement at the triacs
- Hours of operation counter
- DMX parameter measurement and display
- Individual channel pre-heating
- Variable maximum output limits for each channel
- Individual channels assignable as dimming or switching (on/off)
- Individual switching channel pre-heating(for loads with alogen lamps+trasformer).
- 9 scenes programmable in the **DIGifactor** for use in absence of a control console
- Reset function
- DMX 512 via XLR 5/M socket
- Daisy chaining of **DIGifactor** and other DMX 512 units via XLR 5/F plugs
- 0/+10V DC connection via 2 Locking din (8 pole)
- Internal +20 V DC powersupply

3. Mechanical installation

Installation into a rack-case or a fixed installation should follow certain procedures to ensure correct operation of the unit.

Attenzione!

DIGifactor 12 ch 2 Kw is mechanically constructed to suit standard 19" rack mounting

Load voltage regulation is via internally mounted Triacs; these components will heat up when a load is connected; the **DIGifactor 12 ch 2 Kw** needs to dissipate this heat and for this reason the unit needs to be located in a well-ventilated position, leaving a minimum of 2 centimetres clearance around the unit housing and any adjoining surfaces.

Note that on either side of the **DIGifactor** there are forced-cooling air intake/exhaust passages. These passages should under no circumstances be covered.

Installation should not be onto a flammable surface; a hot housing is indicative of abnormal operating conditions.

Ambient operating temperature range: -10°C to +40°C.

If the ambient operating temperature exceeds that indicated, you may choose to install a forced-air cooling system into your **DIGifactor** rack case or mounting system to remove hot air from the housing.

After having installed the **DIGifactor**, refer to section 9.2.3 of this manual, "Temperature testing" to complete the correct installation of the unit.

Note that maximum operating temperature should be measured only after all load has been connected and been operating for a minimum of one hour.

DIGifactor 12 ch 2 Kw is fitted with side mounting rails which allow it to be easily mounted into a range of rack cases of variable depth.

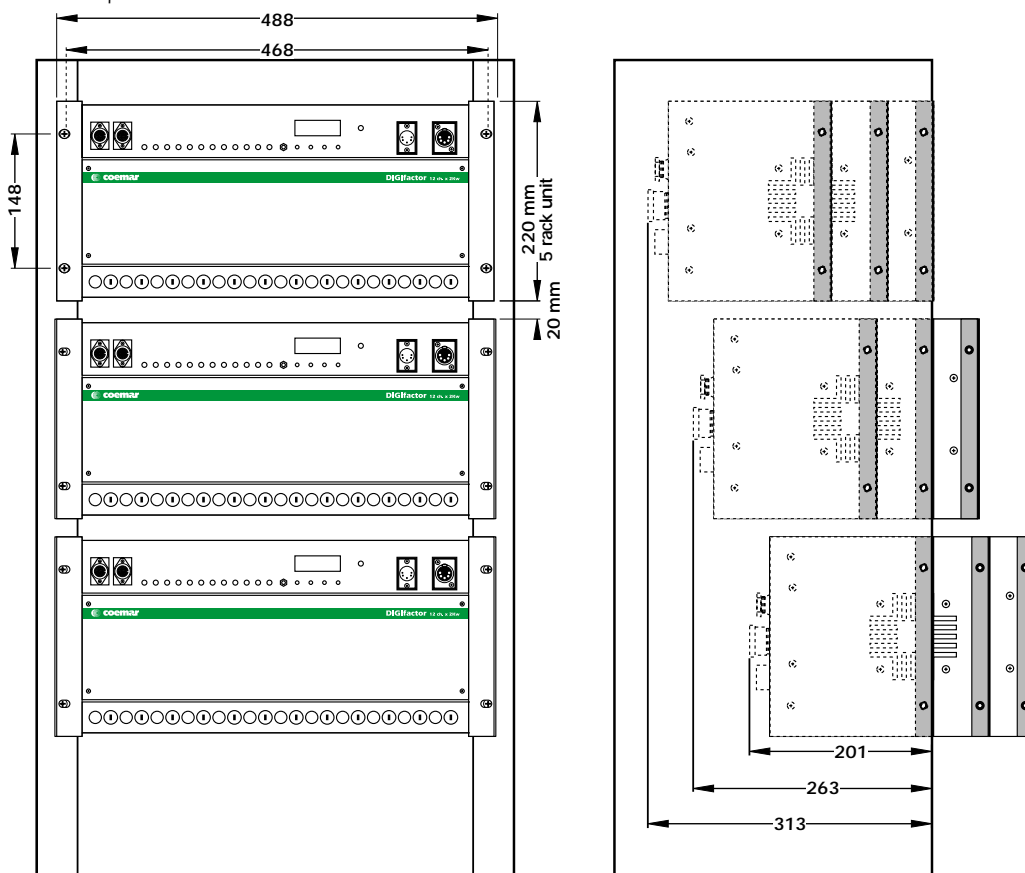

4. Connection to mains power

DIGIfactor 12 ch 2 Kw is a dimmer rack suitable for power supply via 3 phase 380V star or delta. 230V single phase supply is possible, but will not allow the unit to be used in adherence to certain safety norms concerning electrical operation and electromagnetic radiation emission. Strict adherence to local regulatory requirements is essential; as is a correct and secure earth connection. Ensure the supply cable is able to carry the maximum load for the unit.

1) Loosen the four screws (A) which affix the rear panel (B).

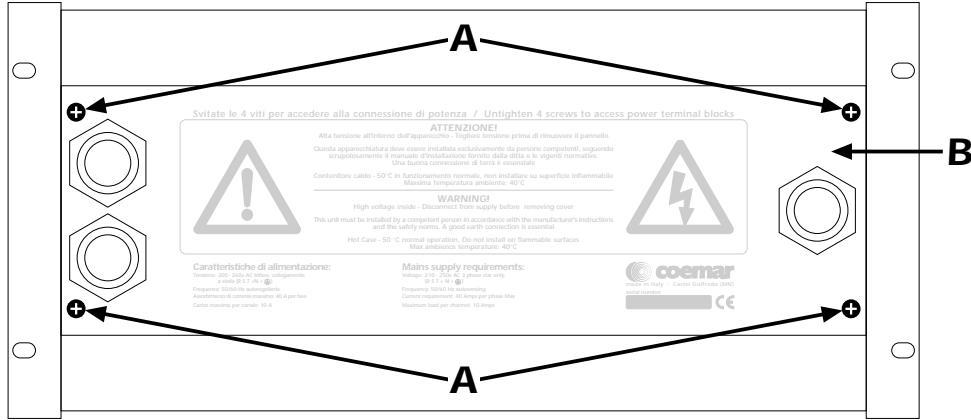

2) Locate the power supply terminal strip (D).

3) Slide your supply cable through the cable clamp till sufficient length is available for connection to the terminal strip.

4) Fix the cable clamp to the cable securely.

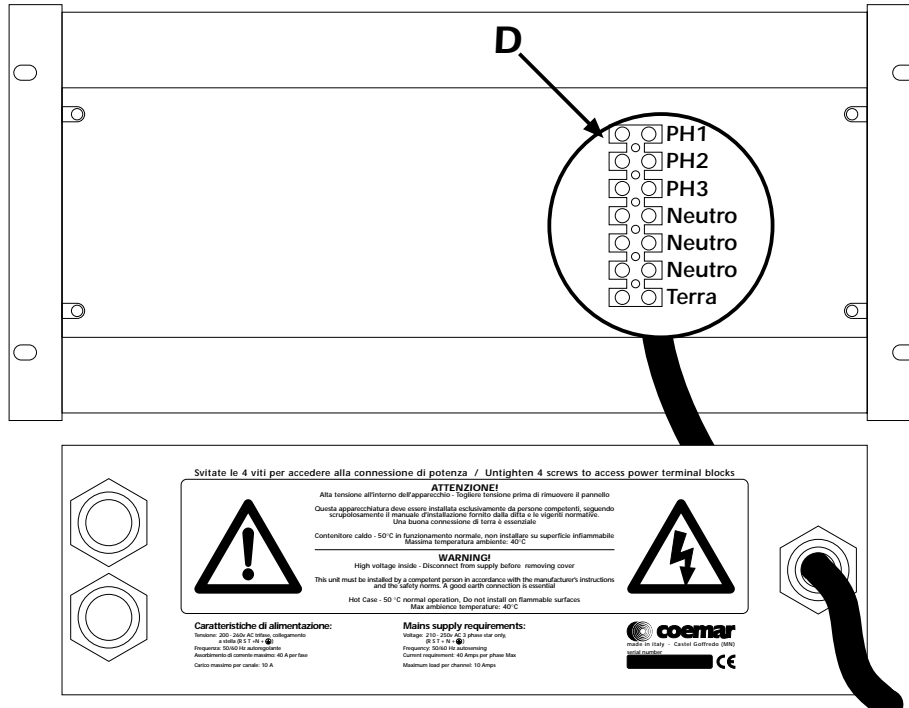

5) Connect the cable as shown in the diagram.

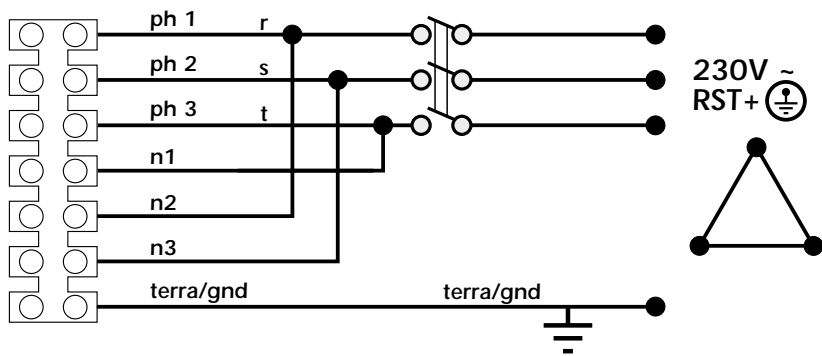
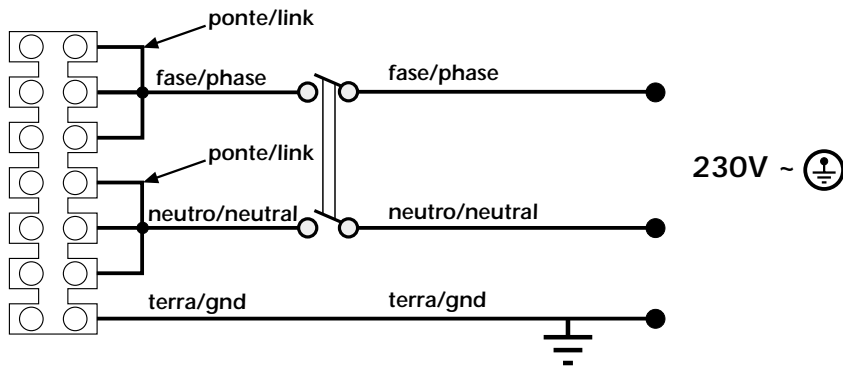
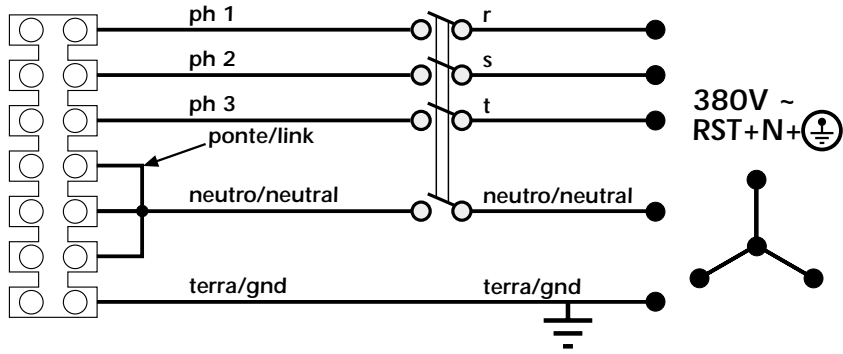

protection

For proper powering up of the **DIGifactor 12 ch 2 Kw** we recommend the use of a thermal/magnetic circuit breaker of sufficient rating, as indicated in the diagram.

Attention

DIGifactor 12 ch 2 Kw is a high-technology dimmer running on mains power; only qualified personal should perform installation, after thorough examination of this manual, and bearing in mind all local norms. Remove mains power prior to removing the rear panel and performing any internal procedures.

The housing may be hot, 50°C during normal operation, do not install on flammable surfaces. Maximum ambient temperature: 40°C

5. Load connection

DIGifactor 12 ch 2 Kw can control a maximum of 12 channels @ 2.3 Kw per channel; a maximum of 10 Amps per channel.
Do not overload the outlets!

Refer to local regulations and norms with respect to the correct cabling required for connection of loads to dimmers in public locations.

A good and secure earth connection is essential.

- 1) Loosen the four screws on the rear of the **DIGifactor 12 ch 2 Kw**; using two multipoles cables of suitable rating, slide the cables through the cable holders (A) located at the rear of the unit and secure them firmly.



- 2) Loosen the four screws which affix the rear panel (A), allowing access to the load terminal strips.

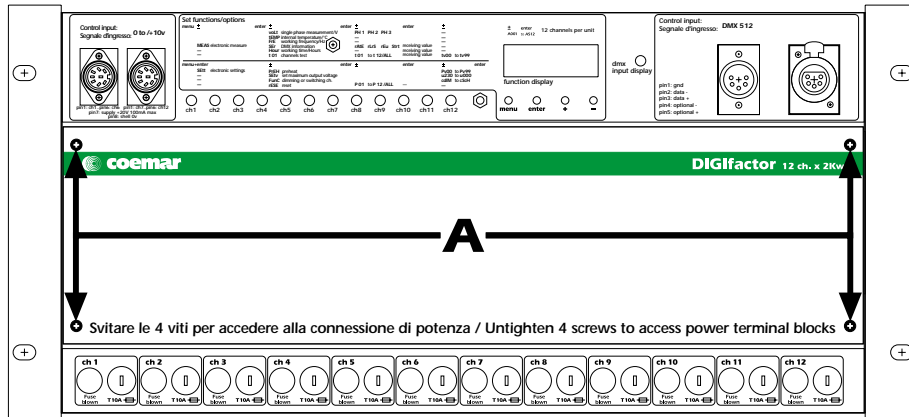

- 3) Load cables should be carefully passed through the rear of the dimmer through the appropriate passage at the left of the unit, located near the cooling fans.

- 4) Connect the load cables, referring to the schematic shown, where a standard load is indicated by lamps.

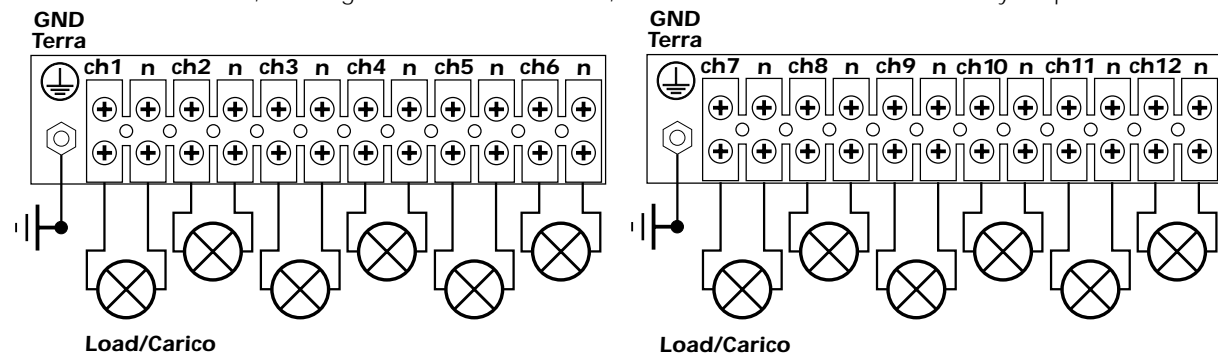

- 5) Close up the front and rear of the **DIGifactor**; noting that for any required inspection of the cables the unit may be inspected from either the front or back, without having to remove it from its mountings.

6. Signal connection

DIGifactor operates on the two most common control signals used in the lighting industry: digital DMX 512 and analogue 0/+10V dc.

6.1 DMX 512

DIGifactor 12 ch receives, via an XLR 5 plug, 12 channels of DMX 512 digitally addressed as 1 to 12; using the signals to control the output levels of 12 channels in the range of 0 to 255, as per the DMX 512 standard, regulated by USITT (U.S Institute of Theatre Technology)

Connection between the DMX 512 controller and the **DIGifactor** follows the recognised standard:

Pin 1= Ground (GND)

Pin 2= DATA -

Pin 3= DATA +

Pin 4= Optional - (not connected)

Pin 5= Optional + (not connected)

If required, the components for making up cables are available from **coemar**:

ME 4966 (Plug XLR 5)

ME 4965 (Socket XLR 5)

CV 4158 (two core screened cable Ø 0.5)

Connection should be via two core screened cable, following all protocols for screened signal cable.

Screening is always connected to pin 1 of the XLR plug and must be isolated from the metallic housing of the plug, with regards to polarity.

A typical DMX 512 connection with **DIGifactor 12 ch 2 Kw** is shown in the diagram.

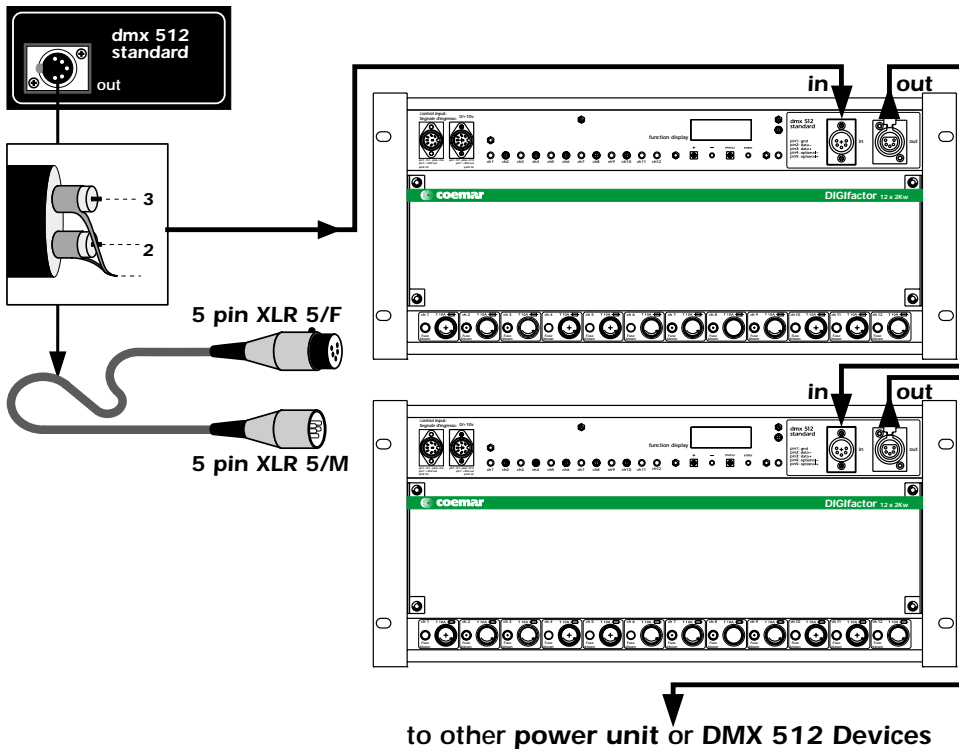

6.2 0/+10VDC

DIGifactor 12 ch 2 Kw receives via a Locking-din plug, 12 variable voltages from 0 to +10V continuous current, as per international norms for analogue transmission.

Connection is particularly simple if the fixture receiving signal follows the **coemar** standard

1st Plug Locking din (8 pole) **DIGifactor 12 ch 2 Kw**

Pin 1= 0/+ 10 V DC channel 1

Pin 2= 0/+ 10 V DC channel 2

Pin 3= 0/+ 10 V DC channel 3

Pin 4= 0/+ 10 V DC channel 4

Pin 5= 0/+ 10 V DC channel 5

Pin 6= 0/+ 10 V DC channel 6

Pin 7=supply + 20 V DC

Pin 8= 0V DC reference

2nd Plug Locking din (8 pole) **DIGifactor 12 ch 2 Kw**

Pin 1= 0/+ 10 V DC channel 7

Pin 2= 0/+ 10 V DC channel 8

Pin 3= 0/+ 10 V DC channel 9

Pin 4= 0/+ 10 V DC channel 10

Pin 5= 0/+ 10 V DC channel 11

Pin 6= 0/+ 10 V DC channel 12

Pin 7=supply + 20 V DC

Pin 8= 0V DC reference

Pin 7 is connected to a +20 V DC stable power supply; this being used for controller which require such voltage for operation.

If the controller being used uses the **coemar** standard you may use pre-made locking din plugs, available from all authorised **coemar** service centres:

Code: 247 (5 metre length)

Code: 248 (10 metre length)

Code: 249 (25 metre length)

Code: 250 (50 metre length)

If required, compomts for the manufacture of cable can be ordered from **coemar**:

ME 261 (Locking-din plug)

CV 924 (screened 8 core cable Ø 0.25, per metre)

CV 4158 (8 core cable Ø 0.25, per metre)

We recommend the use of screened cable; particularly in situations where the possibility of electromagnetic disturbance is high, to reduce to a minimum the possible causes of incorrect functioning of equipment.

Screening should always be connected to pin 8 of the locking-din.

Shown is a typical 0/+10v DC connection between controller and **DIGifactor 12 ch 2 Kw**.

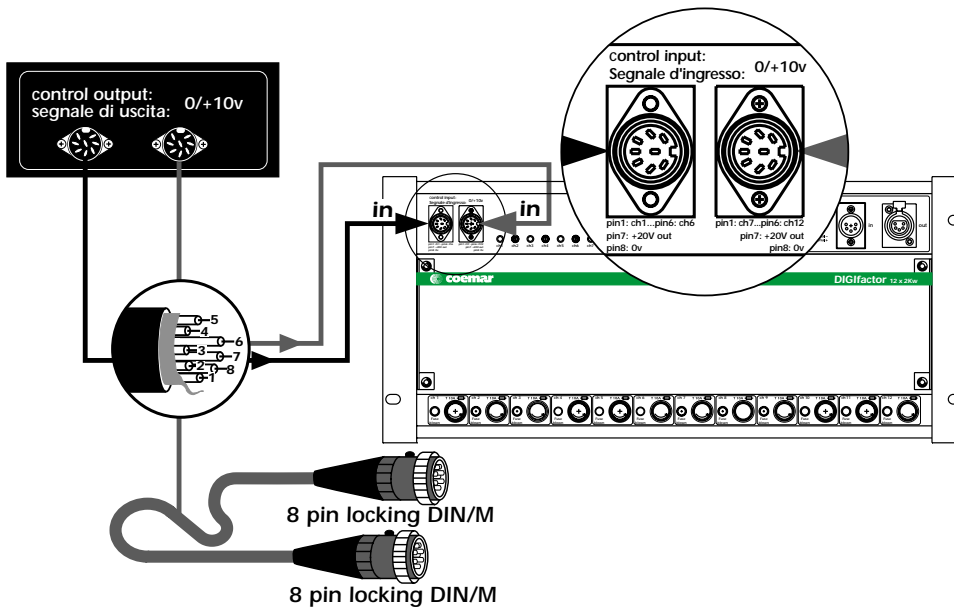

7. Powering up

After having carefully followed the instructions regarding electrical connection and mechanical fixing, the **DIGifactor** may now be powered up via an thermal/magnetic circuit breaker as described in section 4.

Upon powering up, the display will run through a test/reset procedure which begins with a display of the software version installed in the unit, followed by a measurement of the current operating frequency of the power supply and auto-optimisation of the unit's operation.

When the display shows A001 (or any other value preceded by the letter A), the **Digifactor** is ready for normal operation.

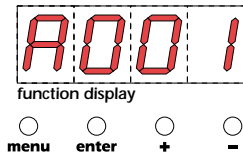

Attention!

If the start-up procedure is not as described above, and the display does not come on, it may be that the power supply is not connected properly; refer to section 4 to re-check connection.

If the display should come on signaling other than that described above, refer to your authorised **coemar** service centre for further advice.

8. DMX addressing or analogue 0/+10v DC

As described in section 6 you may use the **DIGifactor** with either 0/+10V DC or DMX 512 control signals; depending upon the requirements of your controller

8.1 0/10 v DC

After having correctly connected the cable, channel number 1 of the **DIGifactor** corresponds to the signal being sent via pin 1 of the first Locking DIN; channel number 2 corresponds to the signal being sent via pin 2 of the first Locking DIN, and so on until the 12th channel being via pin number 6 of the second Locking din.

A variation in the voltage from 0 to 10 V of the control signal corresponds to a variation of the load voltage from 0 to 230 V.

8.2 DMX 512

After correct connection of the DMX 512 signal cable, the 12 channels of the dimmer are controlled via 12 channels of your DMX controller in sequence.

Upon first turning on the dimmer's display shows **A001** indicating the address **DMX 1**.

A dimmer so addressed will respond to channels **1** through **12** of the **DMX 512** controller, a second dimmer should be addressed as **13**, and so on in multiples of 12.

A dimmer can therefore respond to whichever 12 sequential channels of the controller you wish simply by changing the display's address.

Note that after the first address is set, **DIGifactor** will also occupy the next 11 addresses as well.

changing the dmx address

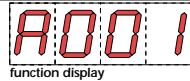
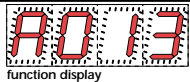
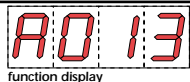
Power up the DIGifactor	 <p>function display</p> <p>○ menu ○ enter ○ + ○ -</p>	Address DMX 001
Press the + or - buttons until the desired channel is shown	 <p>function display</p> <p>○ menu ○ enter ○ + ○ -</p>	Shows the DMX addresses from 1 to 501, the led display will flash, indicating that the change has not been recorded yet.
Press the enter button	 <p>function display</p> <p>○ menu ○ enter ○ + ○ -</p>	Confirms your selection of address, the display stops flashing and the unit responds to the new DMX 512 address.

Important Note: Keeping the **+** or **-** buttons depressed will cause the display to scroll at high speed, allowing for rapid changing.

The presence of DMX signal is indicated by the flashing led in the DMX input display.

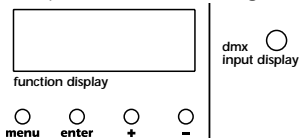

9. Display panel functions

Attenzione! Controls the proper functioning of the dimmer and its various parameters.

Altering the **coemar** factory presents can vary the functioning of the dimmer, causing it to not respond to **DMX 512** control signal; careful and thorough reading of all the following procedures is therefore recommended prior to altering any functions.

IMPORTANT NOTES: these notes are valid for all the functions which follow

1. Keeping the **+** or **-** buttons depressed for 8 seconds for rapid scrolling.
2. You may abort the altering of any function by simply pressing the **menu** button until the display shows the DMX address
3. To immediately go to the maximum value, press the **+** button whilst simultaneously pressing the **-** button.
4. To immediately go to the minimum value, press the **-** button whilst simultaneously pressing the **+** button.
5. You may alter single channel settings or press the **+** or **-** buttons until the display shows **ALL** to alter all channels simultaneously.
6. Changes made via the menu buttons are confirmed and recorded when the **enter** button is pressed.
It is always possible to over-write any settings with new ones at any time.
The reset procedure allows all settings to be returned to factory presets, with the exception of the DMX address.
7. Display panel functions remain active for 10 seconds if no changes are made, after which they will return to the DMX address display/

The display panel has three menus and main functions, which are:

9.1. Test

9.2. Electrical and electronic displays

9.3. Advanced functions (installer options)

9.1. Test

9.1.1. Tests every channel

Allows the testing of every outlet of the **DIGifactor**, without the need for a controller.

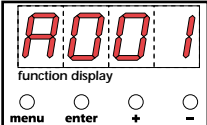
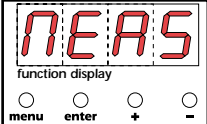
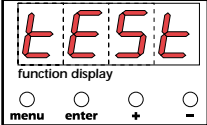
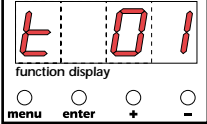
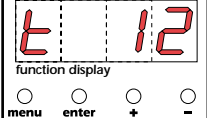
Power up the DIGifactor		Address DMX 001
Press the menu button		electronics display menu
Press the + button		Channel test menu
Press the enter button		To confirm your selection of channel test , the first channel for testing is displayed as 1 (t 01).
Press the + or - buttons to select the required channel for testing		For example, test channel 12 (t 12)

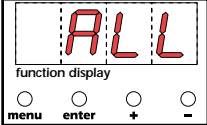
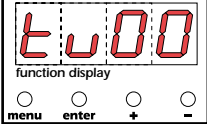
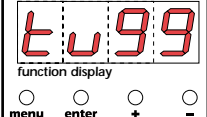

Potete ripetere il test su tutti i canali singolarmente oppure:

Press the + or - buttons		ALL to test all channels simultaneously
Press the enter button		Output level set to 00
Press the + or - button		Select an output level from 0 to 99 (maximum output); via the digital display. As the display value increases, note that the output level of the load does the same.

9.2 Electrical and electronic displays

9.2.1. Voltage display

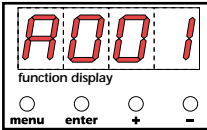
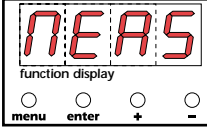

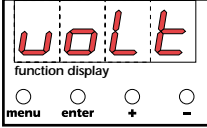
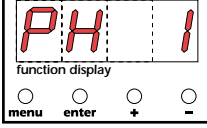
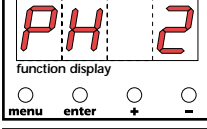
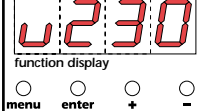
Displays the input voltage across the three phases (in volts).

Power up the DIGifactor		DIGifactor turns on
Press the menu button		Electronic display menu
Press the enter button		To confirm your selection
Press the + or - buttons		voltage displayed
Press the enter button		Voltage measurement for phase 1
Press the + or - button		For example, phase 2
Press the enter button		DIGifactor displays the input voltage, for example, 230 volt.

Pressing the **enter** button in sequence displays the measured input voltage across the 3 phases; phase 1 is always displayed at 4 volts over its actual value, for reasons to do with the internal electronics.

9.2.2. Frequency display

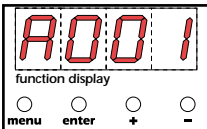
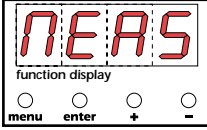
Displays the input voltage frequency (in Hertz).

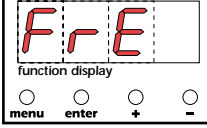
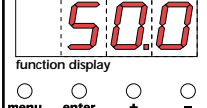
Power up the DIGifactor		DIGifactor turns on
Press the menu button		Electronic display menu
Press the enter button		To confirm your selection
Press the + or - button		FrE measures the frequency in Hertz
Press the enter button		DIGifactor displays the input voltage frequency

9.2.3. Temperature measurement

Displays the instantaneous temperature of the dimmer's internals (in centigrade).

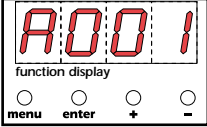
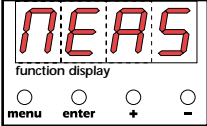
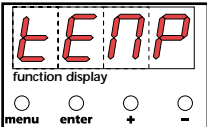
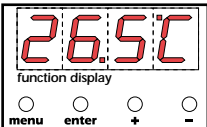
Power up the DIGifactor		DIGifactor turns on
Press the menu button		Electronic display menu
Press the enter button		To confirm your selection
Press the + or - buttons		tEMP temperature display in °C
Press the enter button		DIGifactor displays the temperature, measured at the triacs

The maximum operating temperature of the unit is 85°C. If under full load for some hours the temperature should exceed 65°, re-check the mechanical installation of the unit, which may be incorrect. The forced cooling system may be obstructed, the fan itself may be functioning incorrectly; or simply the unit's cooling system may not be situated in a suitable position to allow heat to be dissipated sufficiently.

In such an instance, the addition of a further fan at the base of the unit, may be appropriate.

9.2.4. DIGifactor hours of operation

Displays the number of hours that the **DIGifactor** has been operated

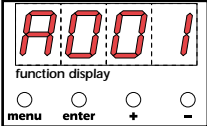
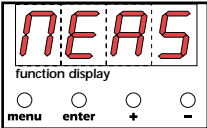
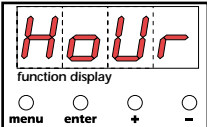
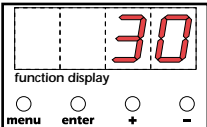
Power up the DIGifactor		DIGifactor turn on
Press the menu button		Electronic menu display
Press the enter button		To confirm your selection
Press the + or - button		HoUr display in hours
Press the enter button		DIGifactor displays the amount of time, in hours, it has been operational, for example, 30.

9.2.5. DMX 512 parameters display

Displays significant parameters of the **DMX 512** signal, bringing any problems to light

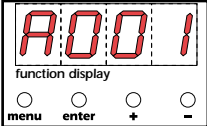
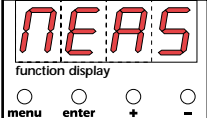
Power up the DIGifactor		DIGifactor turns on
Press the menu button		Electronic display menu

Press the enter button		To confirm your selection
Press the + or - button		SEr displays significant parameters of the DMX 512 signal
Press the enter button		To confirm your selection
Press the + or - button		rAtE measures the frequency at which DIGifactor receives a new packet of signal (DMX)
Press the enter button		DIGifactor displays the value in Hertz

Recommended values: Minimum 1, maximum 44 Hz.

or

Press the + or - button		Strt the first bit after a reset signal (DMX)
Press the enter button		DIGifactor displays the reading

See section 11 for information regarding error messages.

9.2.6. Measuring the signal level for each channel with DMX 512 signal

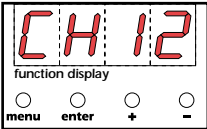
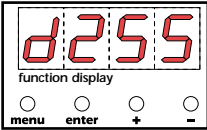

Displays the DMX value (from 0 to 255) originating from the console on 12 channels.

Power up the DIGifactor		DIGifactor turns on
Press the menu button		Electronic display menu
Press the + or - buttons until InSG is displayed		input signal menu
Press the enter button		To confirm your request
Press the + or - buttons until dMX is displayed		Displays DMX 512 input signal
Press the enter button		channel 1

Press the + or - buttons to select the required channel		For example, channel 12
Press the enter button		Displays the DMX input signal value for the selected channel. For example, a level of 255 is shown in the diagram.

9.2.7. Measuring the signal level for each channel with 0/10V DC signal

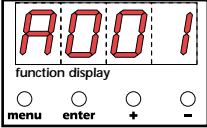
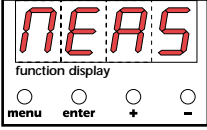
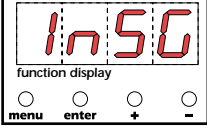
Displays the 0/10V DC value (from 0 to +10V) originating from the console on 12 channels.

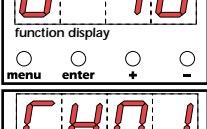
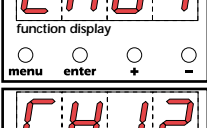
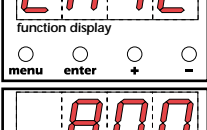
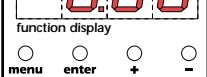
Power up the DIGifactor		DIGifactor turns on
Press the menu button		Electronic display menu
Press the + or - buttons until InSG is displayed		input signal menu
Press the enter button		To confirm your request
Press the + or - buttons until 0-10 is displayed		Displays 0/10V DC input signal
Press the enter button		channel 1
Press the + or - buttons to select the required channel		For example, channel 12
Press the enter button		Displays the 0/10V DC input signal value for the selected channel. For example, a level of 8 volts is shown in the diagram.

9.2.8. Measuring the output voltage on each channel

Displays the output voltage (in volts) on 12 channels. The value is the result of both the signal level and the internal settings chosen from the menu, such as preheating or the selection of a switching channel.

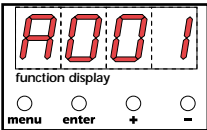
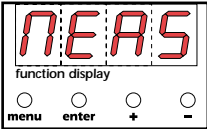
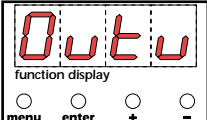
Power up the DIGifactor		DIGifactor turns on
Press the menu button		Electronic display menu
Press the + or - buttons until Outv is displayed		Displays the output voltage

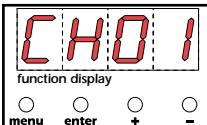
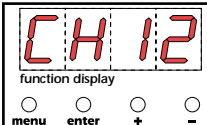
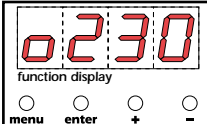

Press the enter button		To confirm your request
Press the enter button		channel 1
Press the + or - buttons to select the required channel		For example, channel 12
Press the enter button		Displays the output voltage level RMS on the selected channel (in volts). For example, a level of 230 volts is shown in the diagram.

9.3. Advanced functions (installer options)

ATTENTION! Modifying these settings will modify the operation of the **DIGifactor**, Use these functions only when necessary.

9.3.1. Lamp pre-heating

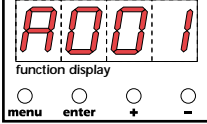
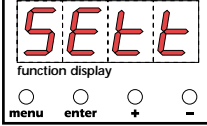
Causes sufficient voltage to be applied to the lamp load to assist in preventing lamp failure due to large thermal differences between lamp on and lamp off states.

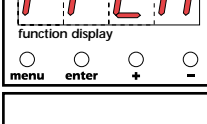

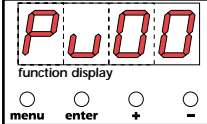
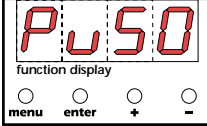

Power up the DIGifactor		DIGifactor turns on
Simultaneously press the menu and enter buttons		Function menu displayed
Press the enter button		To confirm your selection
Press the + or - button		To display the lamp pre-heat menu PrEH
Press the enter button		To confirm your selection
Press the + or - button until the required channel is selected		For example, number 12

NOTE: ATTENTION! You may set individual pre-heat values for each channel or, by pressing the **+** or **-** buttons till **ALL** is displayed, you may address and set all the channels simultaneously

Press the enter button		Pre-heating set at level 0
Press the + or - buttons until the required level is achieved.		DIGifactor sets the dimmer channel(s) to the set minimum level, regardless of incoming DMX signal
Press the enter button		To set the level in memory

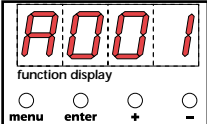
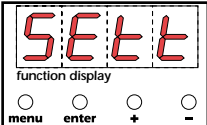
9.3.2. Setting individual channel output voltage limits

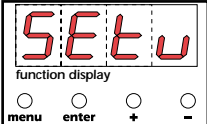
Sets a maximum output voltage (between the maximum output voltage and 180V) which the selected channel can achieve. Suitable if the dimmer is located close to the generator or sub-station by preventing lamp failure due to over-voltage supply.

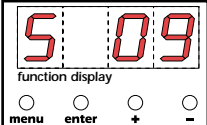
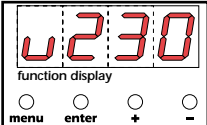

Power up the DIGifactor		DIGifactor turns on
Simultaneously press the menu and enter buttons		Function menu displayed
Press the enter button		To confirm your selection
Press the + or - button		Maximum output voltage menu displayed SEtV
Press the enter button		To confirm your selection
Press the + or - button to select the required channel		For example, channel 9
Press the enter button		Maximum output voltage is selected.

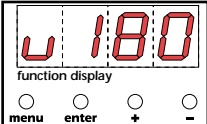
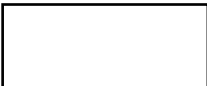
The output voltage is set as a percentage of the incoming supply, for ease of use **DIGifactor** displays a voltage value, this value is approximate, not real.

Press the + or - button		You may reduce the voltage down to 180V=22%
Press the enter button		To confirm your selection

9.3.3. Setting channels to on/off operation (switching)

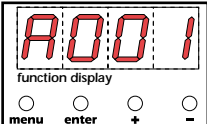
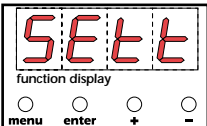
Allows selected channels to be set to on/off only. The channel will remain off up to 50% and on from 50% to 100%, it will not allow the voltage to be regulated to any other value.

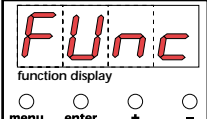
Power up the DIGifactor		DIGifactor turns on
Simultaneously press the menu and enter buttons		Function menu displayed
Press the enter button		To confirm your selection
Press the + or - buttons until FUnc is displayed		switching (on/off) or dimming menu is displayed

Press the enter button		To confirm your selection
Press the + or - buttons until the required channel is selected.		For example, channel 1
Press the enter button		To confirm your selection
Press the + or - button until cdim is displayed		Dimmer function
Press the + or - button until ScHO is displayed		Switching standard function
Press the + or - button until Sch1 is displayed		Transformer switching function (allows pre-heat to be assigned)
Press the enter button		To confirm your selection

9.3.4. Switching channel pre-heating

Causes sufficient voltage to be applied to the channel's load to assist in preventing lamp/transformer failure due to large thermal differences between fixture on and off states. You may select this function only if the channels have been set to switching **Sch1** as described above.

Power up the DIGifactor		DIGifactor turns on
Simultaneously press the menu and enter buttons		Function menu displayed
Press the enter button		To confirm your selection
Press the + or - button until PrEH is displayed		Lamp pre-heating
Press the enter button		To confirm your selection
Press the + or - button until the required channel is selected		For example, channel 12 previously set to Sch1
Press the enter button		Pv00 pre-heat at level 0

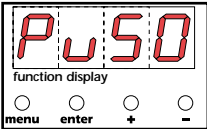
Press the + or - button until the required output voltage is achieved		DIGifactor sets the dimmer channel(s) to the set minimum level, regardless of incoming DMX signal
Press the enter button		To record the level in memory

9.3.5. Setting the response curve for the strike signal

Sets the type of output voltage value depending on the input signal. There are two possible curves:

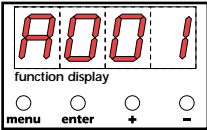
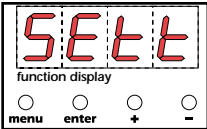
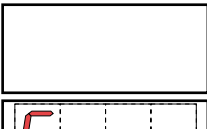
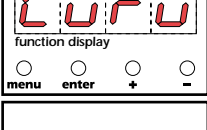
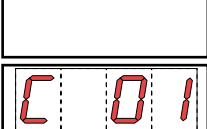
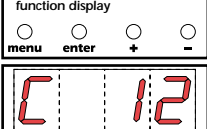
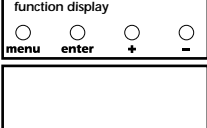

Standard: commonly used in the illuminotechnical field for years in which the strike angle from the triak is directly proportional to the control signal and the luminous intensity is less at the beginning and at the end of the adjustment.

Linear: the strike angle from the triak is linear, the luminous intensity is perfectly proportional to the input signal level.

Power up DIGifactor		DMX address
Simultaneously press the menu and enter buttons		menu is activated
Press the enter button		To confirm your selection
Press the + or - buttons until Curv is displayed		Initiates response curve setting procedure
Press the enter button		To confirm your request
Press the enter button		channel 1
Press the + or - buttons to select the required channel		For example, channel 12
Press the enter button		To confirm your request
Press the + or - buttons until Strd is displayed		Sets standard curve
alternatively		
Press the + or - buttons until Lin is displayed		Sets linear curve
Press the enter button		To confirm your selection



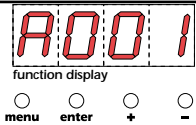
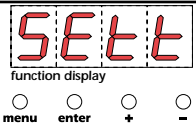
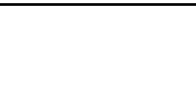
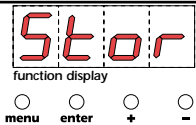

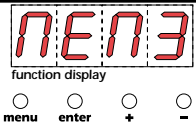
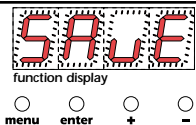
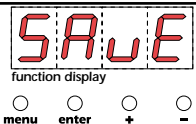
9.3.6. Recording output levels

Allow the recording of up to 9 lighting scenes which may be played back at anytime without the need for an external playback controller

Power up the DIGifactor		DIGifactor turns on
Simultaneously press the menu and enter buttons		Function menu displayed
Press the enter button		To confirm your selection
Press the + or - buttons until Stor is displayed		Level recording
Press the enter button		To confirm your selection
Press the + or - buttons until the number of the required memory is displayed		For example, number 3
Press the enter button		DIGifactor reads the incoming signal, 0/+10V or DMX 512 . The display will flash to indicate that the recording is unconfirmed.
Press the enter button		To confirm your request to record the scene

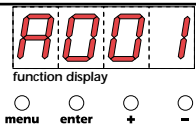
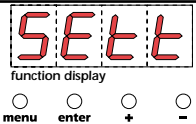
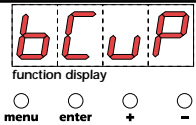
9.3.7. Selecting back-up scene

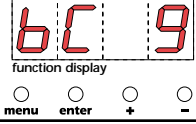
Selects one of the previously recorded scenes (as described in paragraph 16) to be initialized by means of an external comand, by remote or directly from the mixer (see instruction manual for correct connections).

Power up the DIGifactor		DIGifactor turns on
Simultaneously press the menu and enter buttons		Function menu displayed
Press the + or - buttons until bCuP is displayed		Activates the back-up function
Press the enter button		To confirm your selection
Press the + or - buttons until the number of the desired scene for back up by remote is shown		For example, number 9 previously recorded
Press the enter button		To confirm your selection

9.3.8. Protection against overheating

Selects one of three possible programs to be activated by **DIGifactor** in case of overheating of the power zone:

off: no protection

Pr 1: if the temperature reaches 75 °C, the channels previously set as dimmer reduce their maximum voltage level by up to 50% and the switching channels do not change their function.

Pr 2: if the temperature reaches 75 °C, the channels previously set as dimmer reduce their maximum voltage level by up to 50% and the function of the switching channels is entirely disable.

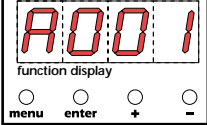
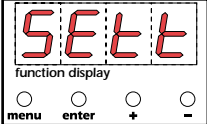
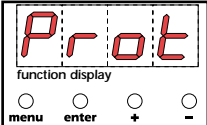
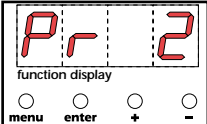
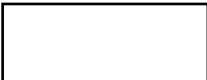
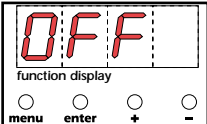
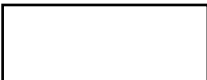
Power up the DIGifactor		DIGifactor turns on
Simultaneously press the menu and enter buttons		Function menu displayed
Press the + or - buttons until Prot is displayed		type of protection menu
Press the + or - buttons to select the required type of protection		For example Pr 2
Press the enter button		To confirm your selection
alternatively		
Press the + or - buttons until OFF is displayed		Protection disabled
Press the enter button		To confirm your selection

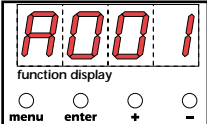
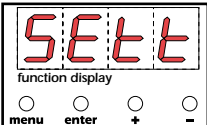
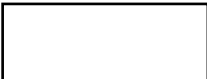
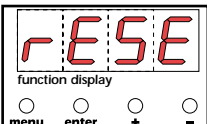
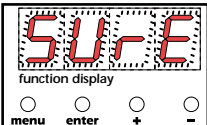
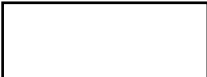

9.3.9. Resetting the DIGifactor

Allow the **DIGifactor** functions previously altered to be reset (except for DMX address).

Power up the DIGifactor		DIGifactor turns on
Simultaneously press the menu and enter buttons		Function menu displayed
Press the enter button		To confirm your selection
Press the + or - button until rESE is displayed		A reset of all altered functions, DIGifactor resets to the coemar factory presets
Premete il tasto enter		The display flashes to indicate an unconfirmed reset. To escape at this point, without performing a reset, press the menu button
Premete il tasto enter		To confirm your selection

9.3.10. Viewing recorded scenes

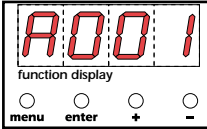
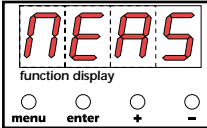
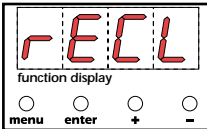
Allows the 9 recorded scenes (as described above) without the need for an external controller.

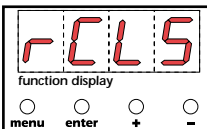
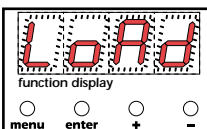
Power up the DIGifactor		DIGifactor turns on
Press the menu button		Electronic display menu
Press the + or - buttons until rECL is displayed		To recall previously recorded scenes
Press the enter button		To confirm your selection
Press the + or - buttons until a previous recording is reached		For example, number 5
Press the enter button		DIGifactor loads the required scene

The display will flash to indicate the request is unconfirmed; to escape at this point press the **menu** button

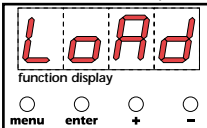
Press the enter button		To confirm your selection
-------------------------------	-------------------------------------------------------------------------------------	---------------------------

From this point **DIGifactor** will output the levels as previously recorded and the address display will include a decimal point, indicating a pre-recorded scene is currently being outputted.

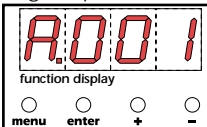
Indicating a pre-recorded scene is currently operational		Note the decimal point between the A and the DMX address
----------------------------------------------------------	-------------------------------------------------------------------------------------	----------------------------------------------------------



NOTE: The pre-recorded scenes may be played back sequentially in the event of temporary control console failure.

NOTE: Pre-programmed scenes played back by the **DIGifactor** are faded in to avoid abrupt lighting changes on-stage.

9.3.11. Switching off pre-recorded scenes

Pre-recorded scenes may be switched off when no longer required.

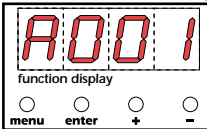
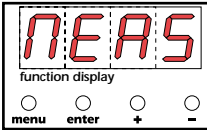
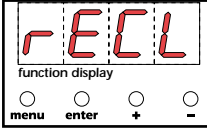
ATTENTION! the following procedure will not erase the scene, it will simply de-activate it until future use.

Power up the DIGifactor		DIGifactor turns on
Press the menu button		Electronic display menu
Press the + or - buttons until rECL is displayed		To recall the previously recorded scene
Press the enter button		To confirm your selection

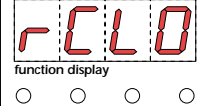
<p>Press the + or - buttons until scene number 0 is displayed</p>		<p>Scene 0 is displayed, non-modifiable</p>
----------------------------------------------------------------------------------------	-----------------------------------------------------------------------------------	----------------------------------------------------

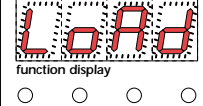
<p>Press the enter button</p>		<p>DIGfactor loads the scene</p>
--------------------------------------	-----------------------------------------------------------------------------------	-----------------------------------------

The display will flash, indicating the need for confirmation; to escape at this point press the **menu** button

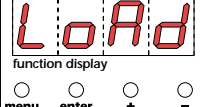
<p>Press the enter button</p>		<p>To confirm your selection</p>
--------------------------------------	-----------------------------------------------------------------------------------	----------------------------------

From this point **DIGfactor** ceases to output the levels of the pre-recorded scene. Note that the address display no longer has a decimal point present.

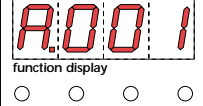
<p>Indicating the absence of a pre-recorded scene</p>		<p>Note the decimal point between the A and the DMX address has switched off</p>
-------------------------------------------------------	-----------------------------------------------------------------------------------	----------------------------------------------------------------------------------

10. Activating a back-up scene by remote

DIGifactor 12 ch 2 Kw gives you the possibility of activating a back-up scene by remote control in case reception of the pilot signal fails. The back-up scene must be programmed as described in paragraph 9.3.7 and activated as explained in the following instructions.

- 1) Loosen the four screws (A) to release the rear panel (B)

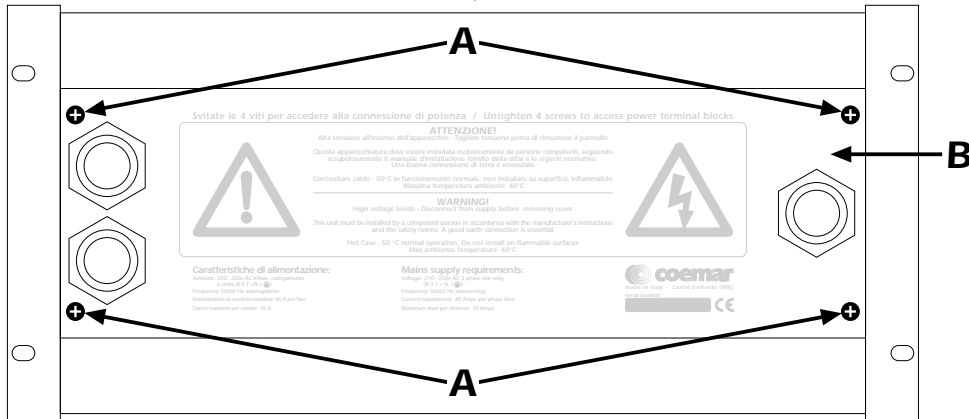

- 2) Locate the terminal block (C).

- 3) Connect a switch to the two poles in the terminal block as shown in the diagram.

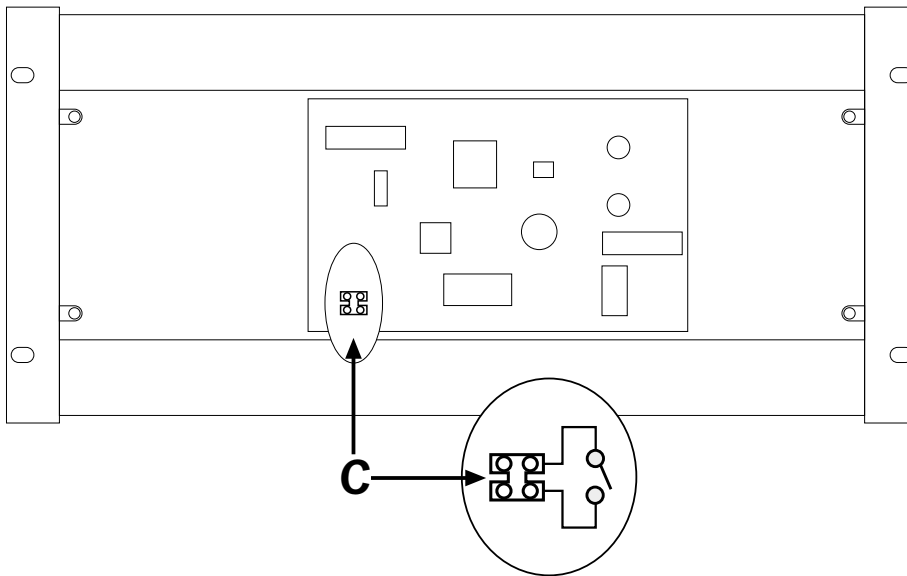

- 4) If the switch is open, **DIGifactor** functions normally; if the contact is closed, however, the back-up scene you have chosen will be activated. The scene will appear in approximately 10 seconds in a way in which no perceptible change in luminous intensity will occur (as is usually the desired effect). One lighted flashing point on the display indicates the activation of a back-up scene.
- 5) To eliminate the back-up scene, simply re-open the switch.

NOTE 1: the scene level is the absolute, DMX 512 and 0/10v DC inputs have no effect

NOTE 2: back-up levels have priority on recall scene

11. Error messages

DIGifactor assists the installer and user in determining the reasons for possible failures; its memory contains the following error messages.

In the majority of cases, it may be advisable to seek the advice of an individual who has experience with the causes of errors which are described below.

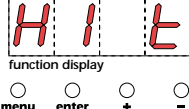
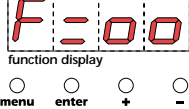
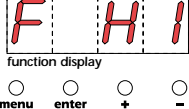
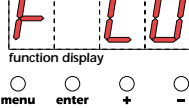
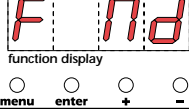
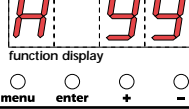
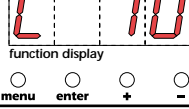
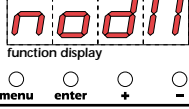
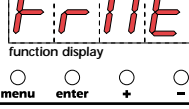
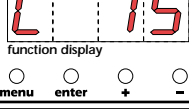
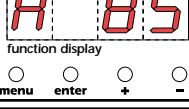
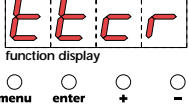
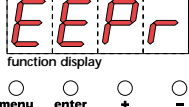
 <p>function display</p> <p>○ ○ ○ ○</p> <p>menu enter + -</p>	<p>The internal temperature has exceeded 65°. The display will flash to indicate an abnormal state. DIGifactor can continue to operate but is in danger of being damaged; adequate ventilation must be provided to resolve this problem</p>
 <p>function display</p> <p>○ ○ ○ ○</p> <p>menu enter + -</p>	<p>An internal hardware failure has occurred which is causing the unit to be unable to determine the operating frequency of 50-60 Hz. This message appears upon start up. Being a hardware problem, the unit will need to be referred to an authorised coemar service centre.</p>
 <p>function display</p> <p>○ ○ ○ ○</p> <p>menu enter + -</p>	<p>The frequency measured at start up exceeds 62 Hz DIGifactor auto sets to 60 Hz; the power supply frequency problem will need to be investigated and the problem rectified in the short term.</p>
 <p>function display</p> <p>○ ○ ○ ○</p> <p>menu enter + -</p>	<p>The frequency measured at start up is below 48 Hz DIGifactor auto sets to 60 Hz; the power supply frequency problem will need to be investigated and the problem rectified in the short term.</p>
 <p>function display</p> <p>○ ○ ○ ○</p> <p>menu enter + -</p>	<p>The frequency measured at start up falls between 52 and 58 Hz, and is therefore not standard. DIGifactor auto sets to 50 Hz; the power supply frequency problem will need to be investigated and the problem rectified in the short term.</p>
 <p>function display</p> <p>○ ○ ○ ○</p> <p>menu enter + -</p>	<p>The frequency, as measured during a electronic menu function exceeds the range of the unit's measurement capacity, which is between 10 and 99 Hz This condition can only be detected by a electronic menu function. The problem will need to be rectified in the short term</p>
 <p>function display</p> <p>○ ○ ○ ○</p> <p>menu enter + -</p>	<p>The frequency, as measured during a electronic menu function falls below the range of the unit's measurement capacity, which is between 10 and 99 Hz This condition can only be detected by a electronic menu function. The problem will need to be rectified in the short term</p>
 <p>function display</p> <p>○ ○ ○ ○</p> <p>menu enter + -</p>	<p>No DMX signal present or not standard DMX 512. Check all DMX connections and the DMX 512 controller which may be switched off</p>
 <p>function display</p> <p>○ ○ ○ ○</p> <p>menu enter + -</p>	<p>The number of channels being transmitted to the DIGifactor are below those indicated by its DMX address. The DMX signal cannot be interpreted correctly as it is incomplete. The dimmer requires more channels of DMX to be sent; consult your controller's manual</p>
 <p>function display</p> <p>○ ○ ○ ○</p> <p>menu enter + -</p>	<p>The temperature is measured at below 15°C and is below the capacity of the unit to measure. This error will not compromise the correct functioning of the dimmer, however, it may indicate that the thermal sensor may have shifted its position in the dimmer's internals, perhaps during transportation. A check of this is recommended.</p>
 <p>function display</p> <p>○ ○ ○ ○</p> <p>menu enter + -</p>	<p>The temperature as measured exceeds 85°C and is above the capacity of the unit to measure; it is imperative that the ventilation of the unit be check and improved before continued use.</p>
 <p>function display</p> <p>○ ○ ○ ○</p> <p>menu enter + -</p>	<p>An error has occurred in the EEPROM data. This error message will be shown immediately after powering up the unit. In this situation DIGifactor will attempt to rectify the error itself; success will depend upon the seriousness of the error. DIGifactor will reset itself after the error has been corrected although it should be noted that data entered via the menu functions may have been lost. Attention! default settings may be incompatible with any switching circuits connected; if this condition is encountered, ensure all functions are returned to your settings.</p>
 <p>function display</p> <p>○ ○ ○ ○</p> <p>menu enter + -</p>	<p>EEPROM access/reading error. DIGifactor will operate only at the factory presets, of any changes made via the menu functions. This error message indicates that the EEPROM is defective or missing. Attention! default settings may be incompatible with any switching circuits connected; if this condition is encountered, ensure all functions are returned to your settings. Refer the unit to your coemar service centre for assistance.</p>

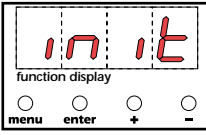

Internal initializing EPROM procedure

12. Maintenance

fuse replacement

The dimmer utilises 12 fuses for load protection

The indicators associated with each channel will indicate a blown fuse; this indicator is easily seen.

Indicators will switch on to indicate a blown fuse, replace each fuse with one of similar dimensions and physical characteristics: T10A ceramic 6,2 X 32mm.

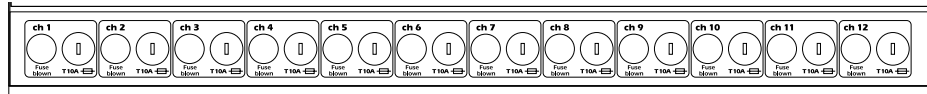

A lamp won't come on

A brief check-list of possible remedies to this situation.

- 1) Check the circuit indicator to see if it shows that a fuse is blown.
- 2) Check the fixture's lamp is not blown.
- 3) Check the controller to isolate the dimmer as the cause of the problem.
- 4) Perform the test procedure as described in section 9.1.1.
- 5) Reset the memory of the EEPROM as indicated in section 9.3.6.
- 6) Following this, re-test the unit as described in section 9.1.1.

If, after this point, the dimmer is still not generating the required output, refer the unit to your authorised **coemar** service centre for assistance with your **DIGifactor**.

replacing a triac

- 1) Loosen and remove the four screws (A) which affix the front panel and access cover.

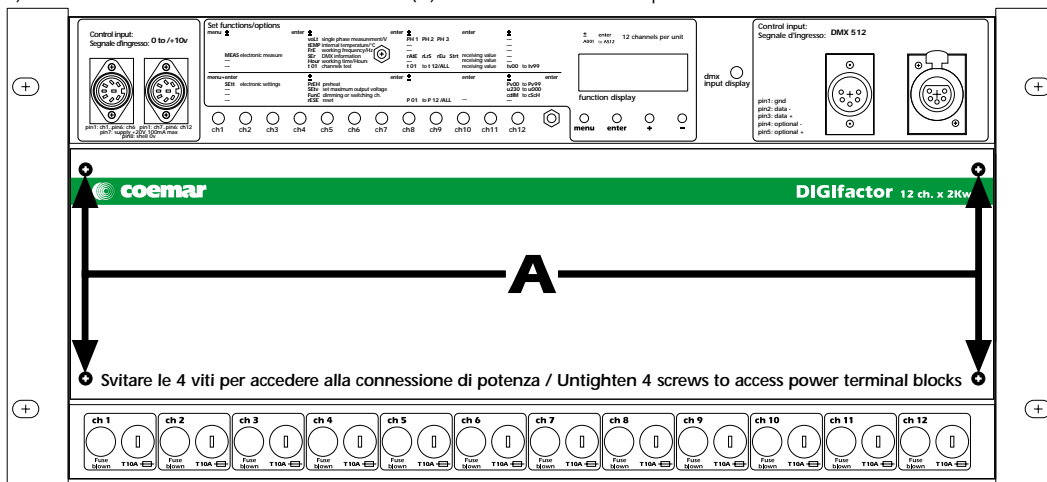

- 2) The metal plate which is seen internally holds the triacs which control the output voltage to each channel. To find the faulty triac, note that the cables which are located at this point are numbered as per the channels (from 1 to 12); the cabling schematic is reproduced in this diagram.

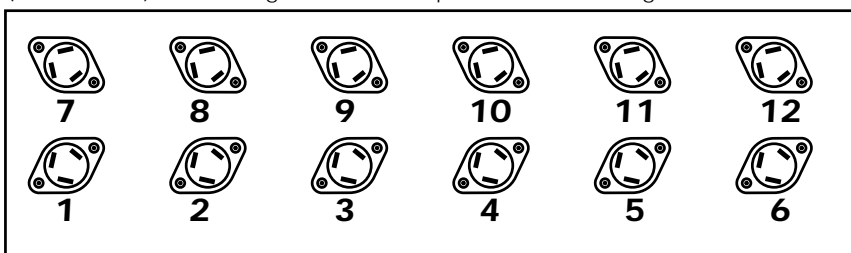

- 3) Locate the faulty component and replace it with an identical part: (BTA25-600B).
- 4) Test the unit is functioning correctly and replace all components and covers.

Periodic cleaning

The fan and air passages should be inspected and cleaned at least every 12 weeks; this period of time may be shorter depending upon the unit's operating conditions.

To effect this cleaning use a common brush, vacuum cleaner, or air compressor.

If necessary, do not hesitate to perform this cleaning more frequently than recommended.

Electronic components.

Check all electrical connections, in particular the earth connection and all removeable connectors. Press all connectors firmly, if necessary, re-affixing them as they were originally.

13. Spare parts

All the components of the **DIGIfactor 12 ch 2 Kw** are available as spare parts from your authorised **coemar** service centre.

To assist us in providing you with prompt and accurate service, carefully specify the model and serial number of the unit, and the spare parts which you require.



coemar spa

via Inghilterra
46042 Castelfredò (Mantova) Italy
Tel. 0376/77521
Fax 0376/780657

coemar reserves the right to effect modifications without notification

instruction manual

DIGifactor 12 ch 2 Kw

3rd edition june 1998